

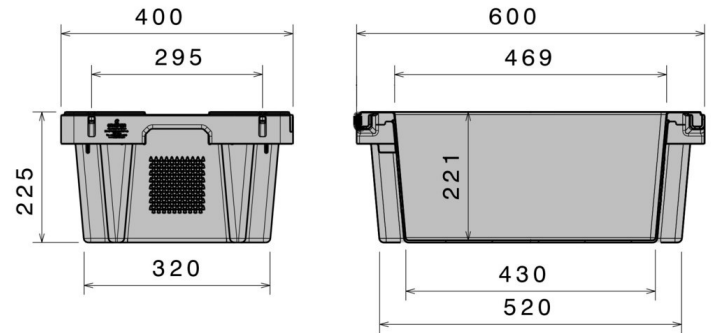





## Stack & Nest Box

30 kg / 32 l



Art.-Nr.: 83861810

| Technical Data*1   |   |  |                 |
|--|---|--|-----------------|
| External Dimensions (mm)   | 600 x 400 x 225   | Internal Dimensions (mm)   | 469 x 354 x 221 |
| Weight (kg)  | 2,1 kg  |  |                 |
| Volume (l)   | 32 l  |  |                 |
| Material*2   | PE  |  |                 |
| Load capacity (kg)   |  <b>Holding Capacity</b><br>30kg |  <b>Extra Load</b><br>300kg   |                 |
| Stacking height (mm)   |  <b>When nested</b><br>50mm      |  <b>When stacked</b><br>205mm |                 |
| Characteristics  |   | Options  |                 |
| Colour: light grey<br>Nestable, stackable<br>For temperatures ranging from -30 °C to +40 °C, briefly up to +90 °C<br>Resistant to most chemicals and cleaning agents<br>Food-safe. HACCP compliant |   | Lid<br>Base perforation<br>Transponder (RFID)  |                 |
| Loading quantities (Pcs / Approximate amount)  |   |  |                 |
| On request   |   |  |                 |
| Labelling  |   |  |                 |
| Customised printing and numbering available on request depending on quantity. Position upon consultation.  |   |  |                 |

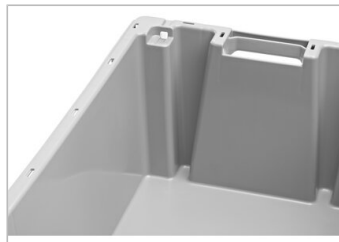

\*1 All technical data include characteristic features, which have been tested under specially defined conditions. Varying data may result from different conditions of usage such as loading method, prevailing temperature and length of storage time. All data and specified information are subject to change without notice. Our service team is pleased to be at your disposal to check the special requirements of your individual application.

\*2 Our service team is pleased to be at your disposal if you require exact information about material compositions.

\*3 Holding capacity: at a room temperature of approx. 20 °C.